

INSPIRON™

SETUP GUIDE



INSPIRON™

SETUP GUIDE

Regulatory model: P17F

Regulatory type: P17F001

Notes, Cautions, and Warnings

 **NOTE:** A NOTE indicates important information that helps you make better use of your computer.

 **CAUTION:** A CAUTION indicates either potential damage to hardware or loss of data and tells you how to avoid the problem.

 **WARNING:** A WARNING indicates a potential for property damage, personal injury, or death.

If you purchased a Dell n Series computer, any references in this document to the Microsoft Windows operating systems are not applicable.

This item incorporates copy protection technology that is protected by U.S. patents and other intellectual property rights of Rovi Corporation. Reverse engineering and disassembly are prohibited.

Information in this document is subject to change without notice.

© 2011–2012 Dell Inc. All rights reserved.

Reproduction of these materials in any manner whatsoever without the written permission of Dell Inc. is strictly forbidden.

Trademarks used in this text: Dell™, the DELL logo, Inspiron™, and DellConnect™ are trademarks of Dell Inc. Intel®, Pentium®, and Core™ are either registered trademarks or trademarks of Intel Corporation in the U.S. and other countries. AMD® and Radeon™ are either trademarks or registered trademarks of Advanced Micro Devices, Inc. Microsoft®, Windows®, and the Windows start button logo  are either trademarks or registered trademarks of Microsoft Corporation in the United States and/or other countries. Bluetooth® is a registered trademark owned by Bluetooth SIG, Inc. and is used by Dell under license. Blu-ray Disc™ is a trademark of the Blu-ray Disc Association.

Other trademarks and trade names may be used in this document to refer to either the entities claiming the marks and names or their products. Dell Inc. disclaims any proprietary interest in trademarks and trade names other than its own.

Contents

Setting Up Your Inspiron Laptop	5	Front View Features	28
Before Setting Up Your Computer	5	Status Lights and Indicators.	30
Connect the AC Adapter	6	Disabling Battery Charging	31
Connect the Network Cable (Optional)	7	Computer Base and Keyboard Features.	32
Press the Power Button	8	Touch Pad Gestures.	36
Set Up the Operating System	9	Multimedia Control Keys	38
Create System Recovery Media (Recommended).	10	Using the Optical Drive	40
Install the SIM Card (Optional)	12	Display Features	42
Enable or Disable Wireless (Optional).	14	Removing and Replacing the Top Cover (Optional)	44
Set Up Wireless Display (Optional)	16	Removing and Replacing the Battery.	48
Connect to the Internet (Optional).	17	Software Features.	50
Using Your Inspiron Laptop.	20	Dell DataSafe Online Backup.	51
Right View Features	20	Dell Stage	52
Left View Features	22		
Back View Features	26		

Contents

Solving Problems	54	Getting Help	74
Beep Codes	54	Technical Support and Customer Service	75
Network Problems	55	DellConnect	75
Power Problems	56	Online Services	76
Memory Problems	58	Automated Order-Status Service	77
Lockups and Software Problems	58	Product Information	77
Using Support Tools	62	Returning Items for Repair Under Warranty or for Credit	78
Dell Support Center	62	Before You Call	80
My Dell Downloads	63	Contacting Dell	82
Hardware Troubleshooter	64	Finding More Information and Resources	84
Dell Diagnostics	64	Specifications	86
Restoring Your Operating System	66	Appendix	93
System Restore	67	Information for NOM, or Official Mexican Standard (Only for Mexico)	93
Dell DataSafe Local Backup	68	Index	94
System Recovery Media	71		
Dell Factory Image Restore	72		

Setting Up Your Inspiron Laptop

This section provides information about setting up your Dell Inspiron laptop.

Before Setting Up Your Computer

When positioning your computer, ensure that you allow easy access to a power source, adequate ventilation, and a level surface to place your computer.

Restricting airflow around your laptop may cause it to overheat. To prevent overheating ensure that you leave at least 10.2 cm (4 inches) at the back of the computer and a minimum of 5.1 cm (2 inches) on all other sides. You should never place your computer in an enclosed space, such as a cabinet or drawer when it is powered on.

 **WARNING:** Do not block, push objects into, or allow dust to accumulate in the air vents. Do not place your Dell computer in a low-airflow environment, such as a closed briefcase, or on fabric surfaces, such as carpets or rugs, while it is powered on. Restricting the airflow can damage the computer, deteriorate the computer performance, or cause a fire. The computer turns on the fan when the computer gets hot. Fan noise is normal and does not indicate a problem with the fan or the computer.

 **CAUTION:** Placing or stacking heavy or sharp objects on the computer may result in permanent damage to the computer.

Connect the AC Adapter

Connect the AC adapter to the computer and then plug it into an electrical outlet or surge protector.

⚠ WARNING: The AC adapter works with electrical outlets worldwide. However, power connectors and power strips vary among countries. Using an incompatible cable or improperly connecting the cable to a power strip or electrical outlet may cause fire or permanent damage to your computer.

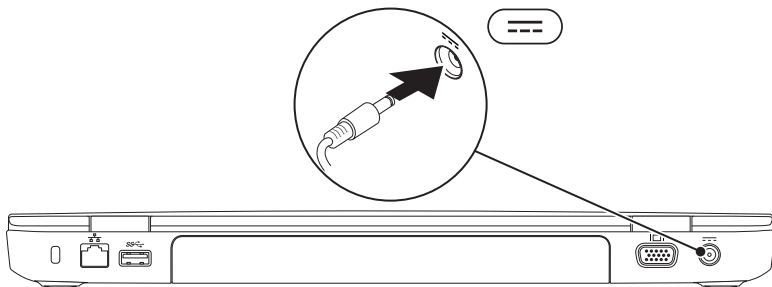

Connect the Network Cable (Optional)

To use a wired network connection, connect the network cable.

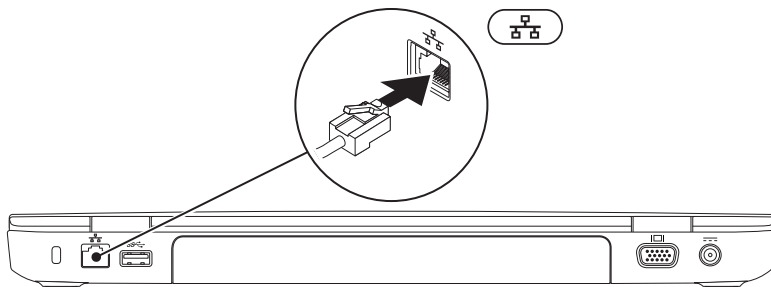

Press the Power Button

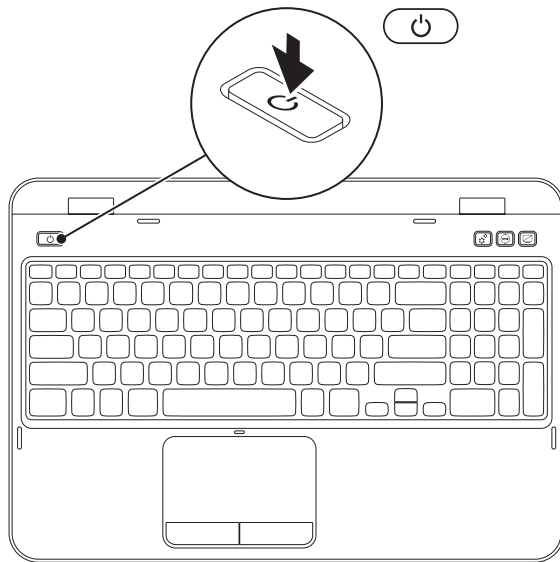



Set Up the Operating System

Your Dell computer is preconfigured with the operating system you selected at the time of purchase.

Set Up Microsoft Windows

To set up Microsoft Windows for the first time, follow the instructions on the screen. These steps are mandatory and may take some time to complete. The Windows setup screens will take you through several procedures including accepting license agreements, setting preferences, and setting up an Internet connection.

 **CAUTION: Do not interrupt the operating system's setup process. Doing so may render your computer unusable and you will need to reinstall the operating system.**

 **NOTE:** For optimal performance of your computer, it is recommended that you download and install the latest BIOS and drivers for your computer available at support.dell.com.

 **NOTE:** For more information on the operating system and features, go to support.dell.com/MyNewDell.

Set Up Ubuntu

To set up Ubuntu for the first time, follow the instructions on the screen. See the Ubuntu documentation for more operating system specific information.

Create System Recovery Media (Recommended)

 **NOTE:** It is recommended that you create system recovery media as soon as you set up Microsoft Windows.

The system recovery media can be used to restore your computer to the operating state it was in when you purchased the computer, while preserving data files (without the need of the *Operating System* disc). You can use the system recovery media if changes to the hardware, software, drivers, or other system settings have left the computer in an undesirable operating state.

You will require the following to create the system recovery media:

- Dell DataSafe Local Backup
- USB key with a minimum capacity of 8 GB or DVD-R/DVD+R/Blu-ray Disc (optional)

 **NOTE:** Dell DataSafe Local Backup does not support rewritable discs.

To create system recovery media:

1. Ensure that the AC adapter is connected (see “Connect the AC Adapter” on page 6).
2. Insert the disc or USB key in the computer.
3. Click **Start**  → **All Programs** → **Dell DataSafe Local Backup**.
4. Click **Create Recovery Media**.
5. Follow the instructions on the screen.

 **NOTE:** For information on restoring your operating system using the system recovery media, see “System Recovery Media” on page 71.

 **NOTE:** It is recommended that you create a password reset disk as soon as you set up Microsoft Windows. For more information, see the Windows 7 support at support.dell.com/MyNewDell.

Install the SIM Card (Optional)

 **NOTE:** The SIM card slot is available in your computer only if you ordered a WWAN card at the time of purchase.

 **NOTE:** Installing a SIM card is not required if you are using an EVDO card to access the Internet.

Installing a Subscriber Identity Module (SIM) card in your computer allows you to connect to the Internet. To access the Internet you must be within the network of your cellular service provider.

To install the SIM card:

1. Turn off your computer.
2. Remove the battery (see “Removing and Replacing the Battery” on page 48).
3. In the battery bay, slide the SIM card into the SIM card slot.
4. Replace the battery (see “Removing and Replacing the Battery” on page 48).
5. Turn on your computer.

To remove the SIM card, press and eject the SIM card.

Setting Up Your Inspiron Laptop

- 1 SIM card slot
- 2 SIM card
- 3 battery bay

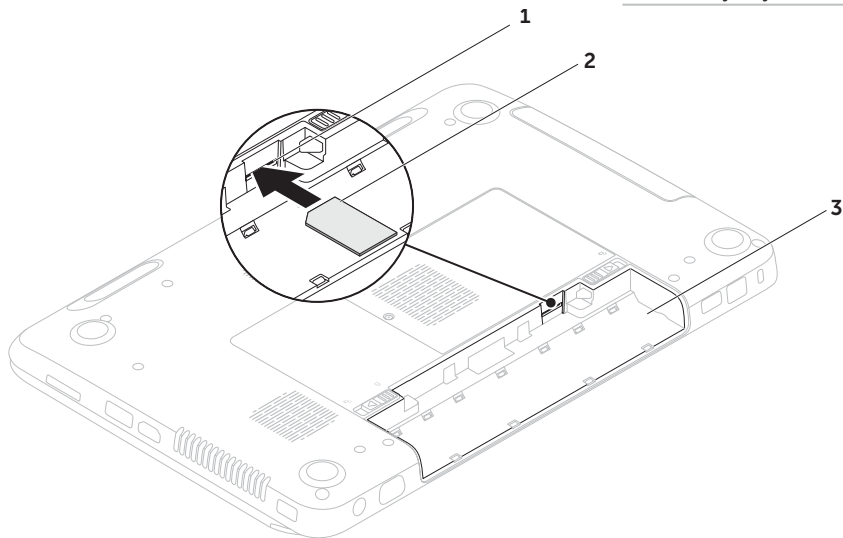

Enable or Disable Wireless (Optional)

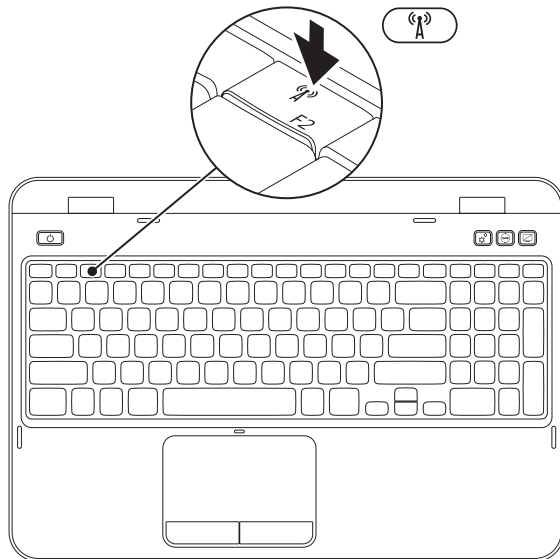

To enable or disable wireless:

1. Ensure that your computer is turned on.
2. Press <Fn> along with the <  > key on the function key row on the keyboard.

The current status of the wireless radios appears on the screen.

Wireless enabled



Wireless disabled



3. Press <Fn> along with the <  > key again to switch between the wireless enabled or disabled states.

 **NOTE:** The wireless key allows you to quickly turn off wireless radios (Wi-Fi and Bluetooth), such as when you are asked to disable all wireless radios on an airplane flight.

Set Up Wireless Display (Optional)



 **NOTE:** The wireless display feature may not be supported on all computers. For information about the hardware and software requirements for setting up wireless display, see www.intel.com.

The Intel wireless display feature allows you to share your computer display to a TV without the use of cables. You must connect a wireless display adapter to your TV before setting up wireless display.

 **NOTE:** The wireless display adapter does not ship with your computer and must be purchased separately.

If your computer supports the wireless display feature, the Intel Wireless Display icon  will be available on the Windows desktop.

To set up wireless display:

1. Turn on your computer.
2. Press <Fn> along with the < > key on the function key row on the keyboard to enable wireless.
3. Connect the wireless display adapter to the TV.
4. Turn on the TV.
5. Select the appropriate video source for your TV, such as HDMI1, HDMI2, or S-Video.
6. Click the Intel Wireless Display icon  on the desktop.
The **Intel Wireless Display** window appears.
7. Select **Scan for available displays**.
8. Select your wireless display adapter from the **Detected wireless displays** list.
9. Enter the security code that appears on your TV.

To enable wireless display:

1. Click the Intel Wireless Display icon  on the desktop.

The **Intel Wireless Display** window appears.

2. Select **Connect to Existing Adapter**.

 **NOTE:** You can download and install the latest driver for “Intel Wireless Display Connection Manager” from **support.dell.com**.

 **NOTE:** For more information about wireless display, see the wireless display adapter documentation.

Connect to the Internet (Optional)

To connect to the Internet, you need an external modem or network connection and an Internet Service Provider (ISP).

If an external USB modem or WLAN adapter is not a part of your original order, you can purchase one from **dell.com**.

Setting Up a Wired Connection

- If you are using a dial-up connection, connect the telephone line to the optional external USB modem and to the telephone wall connector before you set up your Internet connection.
- If you are using a DSL or cable/satellite modem connection, contact your ISP or cellular telephone service for setup instructions.

To complete setting up your wired Internet connection, follow the instructions in “Setting Up Your Internet Connection” on page 19.

Setting Up a Wireless Connection

 **NOTE:** To set up your wireless router, see the documentation that shipped with your router.

Before you can use your wireless Internet connection, you need to connect to your wireless router.

To set up your connection to a wireless router:

1. Ensure that wireless is enabled on your computer (see “Enable or Disable Wireless (Optional)” on page 14).
2. Save and close any open files, and exit any open programs.
3. Click **Start**  → **Control Panel**.
4. In the search box, type `network`, and then click **Network and Sharing Center** → **Connect to a network**.
5. Follow the instructions on the screen to complete the setup.

Setting Up Your Internet Connection

ISPs and ISP offerings vary by country. Contact your ISP for offerings available in your country.

If you cannot connect to the Internet but have successfully connected in the past, the ISP might have a service outage. Contact your ISP to check the service status, or try connecting again later.

Have your ISP information ready. If you do not have an ISP, the **Connect to the Internet** wizard can help you get one.

To set up your Internet connection:

1. Save and close any open files, and exit any open programs.
2. Click **Start**  → **Control Panel**.
3. In the search box, type `network`, and then click **Network and Sharing Center** → **Set up a new connection or network** → **Connect to the Internet**.

The **Connect to the Internet** window appears.

-  **NOTE:** If you do not know which type of connection to select, click **Help me choose** or contact your ISP.
4. Follow the instructions on the screen and use the setup information provided by your ISP to complete the setup.

Using Your Inspiron Laptop

This section provides information about the features available on your Inspiron laptop.

Right View Features

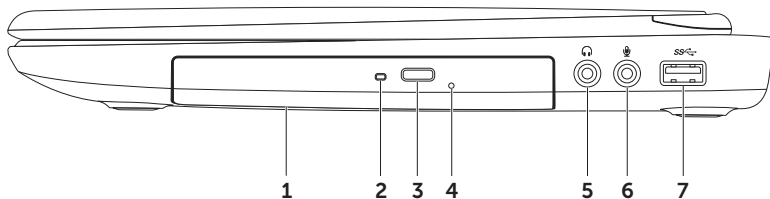



-
- 1 Optical drive** — Plays or records CDs, DVDs, and Blu-ray Discs (optional). For more information, see “Using the Optical Drive” on page 40.

 - 2 Optical drive light** — Blinks when you press the optical drive eject button or when you insert a disc and it is being read.

 - 3 Optical drive eject button** — Press to open the optical-drive tray.

 - 4 Emergency eject hole** — Use to open the optical-drive tray if it does not open when you press the eject button. For more information, see “Using the Emergency Eject Hole” on page 40.

 -  **5 Audio-out/Headphone connector** — Connects to a pair of headphones or to a powered speaker or sound system.

 -  **6 Audio-in/Microphone connector** — Connects to a microphone or inputs signal for use with audio programs.

 -  **7 USB 3.0 connector** — Provides faster data transmission between your computer and USB devices.
-

Left View Features

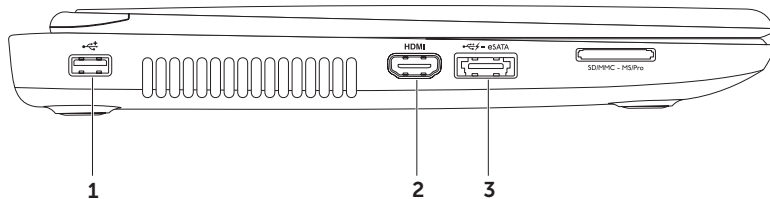

-
- 1  **USB 2.0 connector** — Connects to USB devices, such as a mouse, keyboard, printer, external drive, or MP3 player.

-
- 2  **HDMI connector** — Connects to a TV for both 5.1 audio and video signals.

NOTE: When used with a monitor, only the video signal is read.

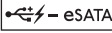
-
- 3  **eSATA/USB combo connector with USB PowerShare** — Connects to eSATA compatible storage devices (such as external hard drives or optical drives) or USB devices (such as a mouse, keyboard, printer, external drive, or MP3 player). The USB PowerShare feature allows you to charge USB devices when the computer is powered on/off or in sleep state.

NOTE: Certain USB devices may not charge when the computer is powered off or in sleep state. In such cases, turn on the computer to charge the device.

NOTE: If you turn off your computer while charging a USB device, the device stops charging. To continue charging, disconnect the USB device and connect it again.

NOTE: The USB PowerShare feature is automatically shut off when only 10% of the total battery life remains.

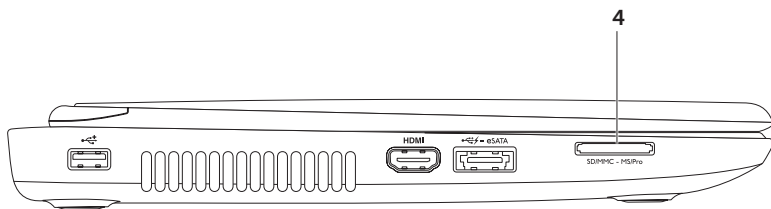

-
- 4 **SD-MMC-MS 8-in-1 Media Card Reader** — Provides a fast and convenient way to view and share digital photos, music, videos, and documents stored on memory cards. For the supported memory cards, see “Specifications” on page 86.

NOTE: Your computer ships with a plastic blank installed in the media card slot. Blanks protect unused slots from dust and other particles. Save the blank for use when no media card is installed in the slot; blanks from other computers may not fit your computer.

Back View Features



1 Security cable slot — Attaches a commercially available security cable to the computer.

NOTE: Before you buy a security cable, ensure that it fits into the security cable slot on your computer.

2  Network connector — Connects your computer to a network or a broadband device if you are using a wired network.





3  USB 3.0 connector — Provides faster data transmission between your computer and USB devices.

4  VGA connector — Connects to a monitor or projector.

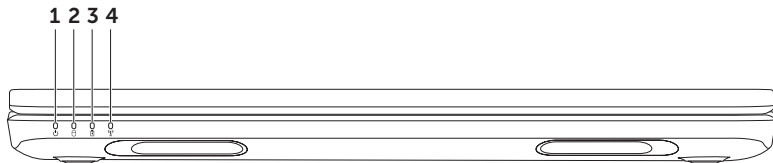
5  AC adapter connector — Connects to the AC adapter to power the computer and charge the battery.

Front View Features



-
-  **Power indicator light** — Indicates the power states. For more information on the power indicator light, see “Status Lights and Indicators” on page 30.
-
-  **Hard drive activity light** — Turns on when the computer reads or writes data. A solid white light indicates hard drive activity.
 **CAUTION: To avoid loss of data, never turn off the computer when the hard drive activity light is on.**
-
-  **Battery status light** — Indicates the battery charge status. For more information on the battery status light, see “Status Lights and Indicators” on page 30.
NOTE: The battery is charging when the computer is powered using the AC adapter.
-
-  **Wireless status light** — Turns on when wireless is enabled. A solid white light indicates that wireless is enabled.
NOTE: To enable or disable wireless, see “Enable or Disable Wireless (Optional)” on page 14.
-

Status Lights and Indicators

Battery Status Light

	Indicator light status	Computer state(s)	Battery charge status
AC adapter	solid white	on/standby/off/ hibernate	charging
	off	on/standby/off/ hibernate	fully charged
Battery	solid amber	on/standby	low battery (<= 10%)
	off	on/standby/off/ hibernate	not charging

 **NOTE:** The battery is charging when the computer is powered using the AC adapter.

Power Button Light/Power Indicator Light

Indicator light status	Computer state(s)
solid white	on
breathing white	standby
off	off/hibernate

 **NOTE:** For information on power problems, see “Power Problems” on page 56.

 **NOTE:** If your computer is in standby or hibernate mode, press and hold the power button for a second to resume the computer back to normal mode.

Disabling Battery Charging

You may be required to disable the battery charging feature while on an airplane flight. To quickly disable the battery charging feature:



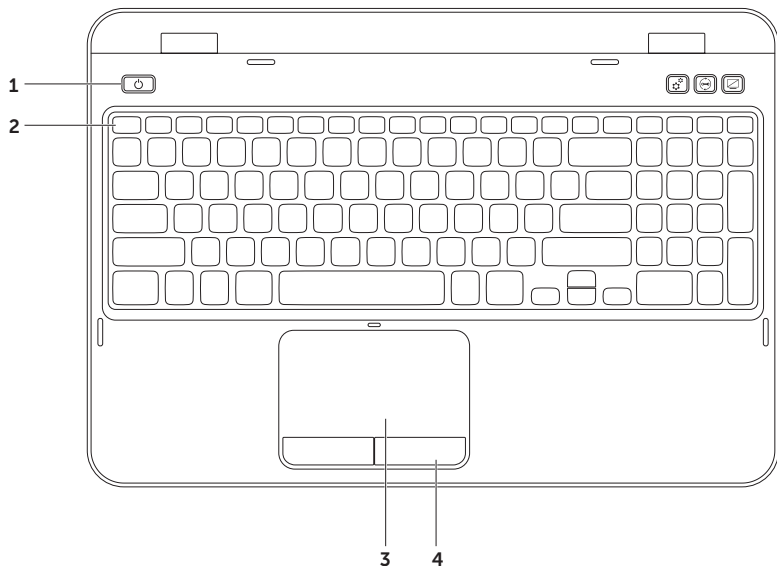

1. Ensure that your computer is turned on.
2. Click **Start** .
3. In the search box, type `Power Options` and press <Enter>.
4. Under **Power Options** window, click **Dell Battery Meter** to open **Battery Settings** window.
5. Click **Turn off Battery Charging** and then click **OK**.

 **NOTE:** Battery charging can also be disabled in the System Setup (BIOS) utility.

Computer Base and Keyboard Features





-
-  **Power button and light** — Press to turn on or off your computer. The light on the button indicates the power states. For more information on the power button light, see “Status Lights and Indicators” on page 30.

 - Function key row** — The dual display enable or disable key , wireless enable or disable key , touch pad enable or disable key , brightness increase  and decrease  keys, and the multimedia keys are located in this row.
For more information on the multimedia keys, see “Multimedia Control Keys” on page 38.

 - Touch pad** — Provides the functionality of a mouse to move the cursor, drag or move selected items, and left-click by tapping the surface.
The touch pad supports the Scroll, Flick, and Zoom features. To change the touch pad settings, double-click the **Dell Touch pad** icon in the notification area of your desktop. For more information, see “Touch Pad Gestures” on page 36.
NOTE: To enable or disable the touch pad, press <Fn> along with the <> key on the function key row on the keyboard.

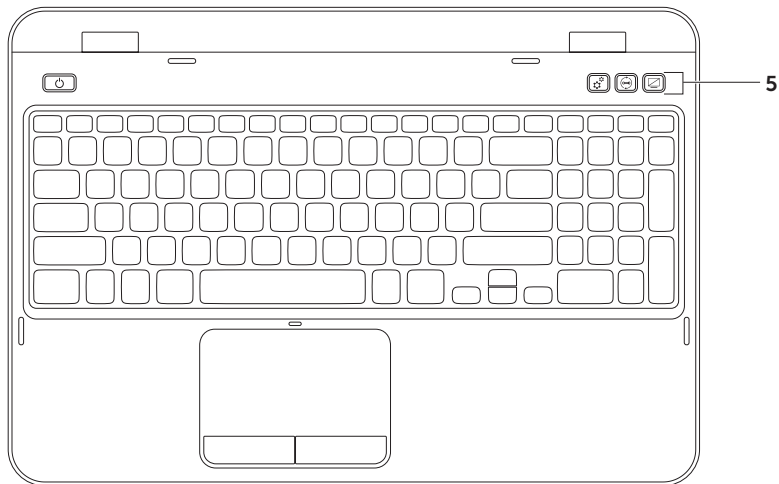
 - Touch pad buttons** — Provide left-click and right-click functions like those on a mouse.
-





- 5  **Windows Mobility Center button** — Press to launch the Windows Mobility Center. Windows Mobility Center provides quick access to your mobile PC settings such as brightness control, volume control, battery status, wireless network and so on.

 **Dell Support Center button** — Press to launch the Dell Support Center. For more information, see “Dell Support Center” on page 62.

 **Display On/Off button** — Press to turn on or turn off the display.

NOTE: The Windows Mobility Center, Dell Support Center, and Display On/Off buttons work only on computers running the Windows operating system.

Touch Pad Gestures

 **NOTE:** Some of the touch pad gestures may be disabled by default. To change the touch pad gestures settings, click **Start**  **→ Control Panel** **→ Hardware and Sound** **→ Devices and Printers** **→ Mouse**.

Scroll

Allows you to scroll through content. The scroll feature includes:

Auto Scroll Vertical — Allows you to scroll up or down on the active window.

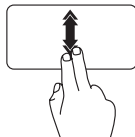

Move two fingers up or down at a fast pace to activate vertical auto scrolling.

Tap on the touch pad to stop auto scrolling.

Auto Scroll Horizontal — Allows you to scroll left or right on the active window.

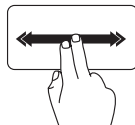

Move two fingers to your left or right at a fast pace to activate horizontal auto scrolling.

Tap on the touch pad to stop auto scrolling.

Zoom

Allows you to increase or decrease the magnification of the screen content. The zoom feature includes:

Pinch — Allows you to zoom in or zoom out by moving two fingers apart or bringing them closer together on the touch pad.

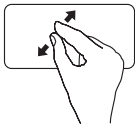

To zoom in:

Move two fingers apart to enlarge the view of the active window.

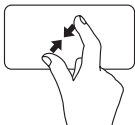

To zoom out:

Move two fingers close together to reduce the view of the active window.

Flick

Allows you to flip content forward or backward based on the direction of the flick.

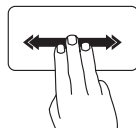

Move three fingers quickly in the desired direction to flip content in the active window.

Multimedia Control Keys

The multimedia control keys are located on the function key row on the keyboard. To use the multimedia controls, press the required key. You can configure the multimedia control keys on the keyboard using the **System Setup** (BIOS) utility or the **Windows Mobility Center**.

System Setup

1. Press <F2> during the Power On Self Test (POST) to enter the System Setup (BIOS) utility.
2. In the **Function Key Behavior**, select **Multimedia Key First** or **Function Key First**.

Function Key First — This is the default option. Press any function key to perform the associated function. For multimedia action, press <Fn> + the required multimedia key.

Multimedia Key First — Press any multimedia key to perform the associated multimedia action. For function, press <Fn> + the required function key.

 **NOTE:** The **Multimedia Key First** option is active only in the operating system.

Windows Mobility Center

1. Press the <Windows><X> keys or press the Windows Mobility Center button  to launch Windows Mobility Center.
2. In the **Function Key Row**, select **Function Key** or **Multimedia Key**.



 Play the previous track or chapter

 Play or pause

 Play the next track or chapter

 Decrease the volume level

 Increase the volume level

 Mute the sound

Using the Optical Drive

 **CAUTION:** Do not press down on the optical drive tray when you open or close it. Keep the optical drive tray closed when you are not using the drive.

 **CAUTION:** Do not move the computer while playing or recording a disc.

The optical drive plays or records CDs and DVDs. Ensure that the side with print or writing is facing upward when placing discs on the optical drive tray.

To place a disc in the optical drive:

1. Press the optical drive eject button on the optical drive.
2. Pull out the optical drive tray.
3. Place the disc, label-side up, in the center of the optical drive tray and snap the disc onto the spindle.
4. Push the optical drive tray back into the drive.

Using the Emergency Eject Hole

If the optical drive tray does not eject when you press the eject button, you can use the emergency eject hole to open the drive tray. To open the drive tray using the emergency eject hole:

1. Turn off the computer.
2. Insert a small pin or unfolded paper clip into the emergency eject hole and push firmly until the optical drive tray opens.

-
- 1 disc

 - 2 spindle

 - 3 optical drive tray

 - 4 emergency eject hole

 - 5 optical drive eject button
-

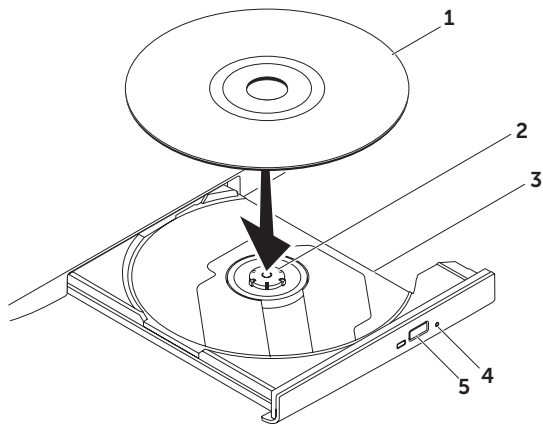

Display Features

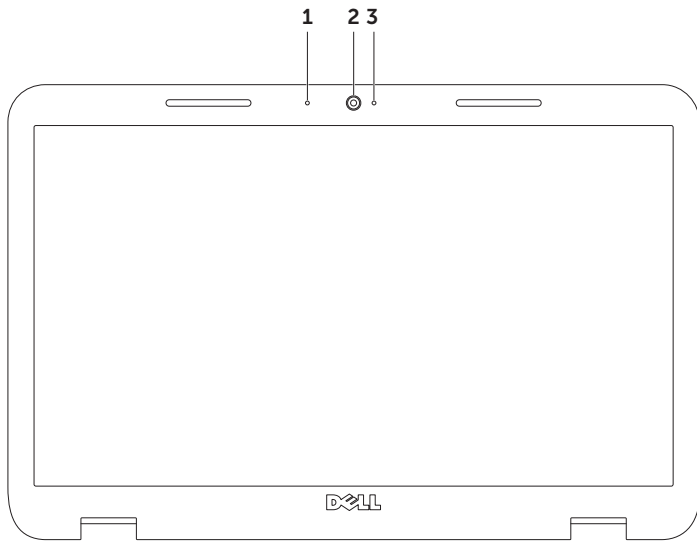

-
- 1 Microphone** — Provides high quality sound for video conferencing and voice recording.
 - 2 Camera** — Built-in camera for video capture, conferencing, and chat.
 - 3 Camera indicator light** — Indicates if the camera is on or off. A solid white light indicates camera activity.
-

Removing and Replacing the Top Cover (Optional)

 **WARNING:** Before you begin any of the procedures in this section, follow the safety instructions that shipped with your computer.

 **WARNING:** Before removing the top cover, shut down the computer, and remove external cables (including the AC adapter).

To remove the top cover:

1. Turn off the computer and close the display.
2. Press and hold the top cover release button, and then slide the top cover.

 **NOTE:** You can purchase additional replaceable top covers at [dell.com](https://www.dell.com).

- 1 back of the computer
- 2 top cover
- 3 top cover release button

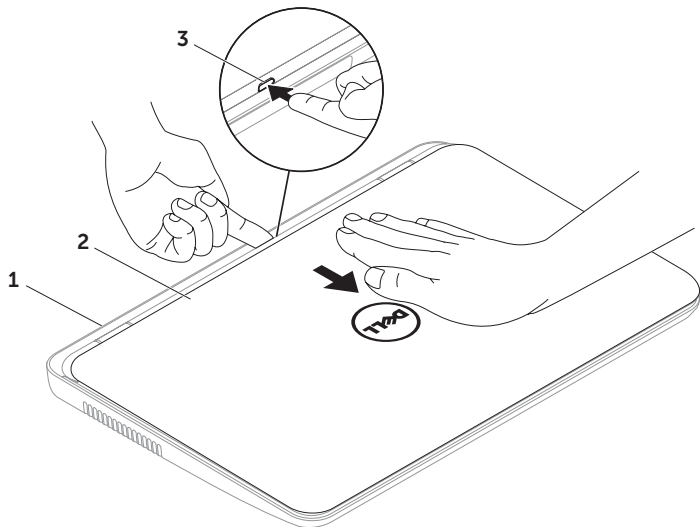

Using Your Inspiron Laptop

To replace the top cover:

 **NOTE:** Ensure that the Dell logo is facing towards the back of the computer while replacing the top cover.

1. Align the top cover to the display back.
2. Slide the top cover until it clicks into place. Ensure that there are no gaps between the top cover and the display back cover.

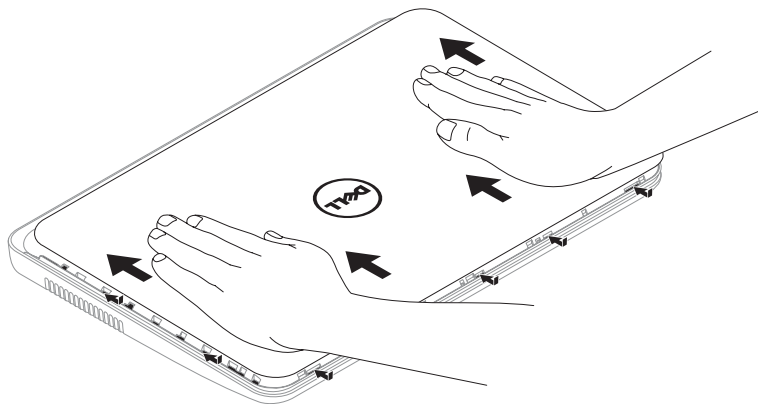

Removing and Replacing the Battery

 **WARNING:** Before you begin any of the procedures in this section, follow the safety instructions that shipped with your computer.

 **WARNING:** Using an incompatible battery may increase the risk of fire or explosion. This computer should only use a battery purchased from Dell. Do not use batteries from other computers.

 **WARNING:** Before removing the battery, shut down the computer, and remove external cables (including the AC adapter).

To remove the battery:

1. Turn off the computer and turn it over.
2. Slide the battery release latch and the battery lock latch to the unlock positions.
3. Slide and lift the battery out of the battery bay.

To replace the battery:

1. Slide the battery into the battery bay until it clicks into place.
2. Slide the battery lock latch to the lock position.

Using Your Inspiron Laptop

- 1 battery lock latch
- 2 battery
- 3 battery release latch

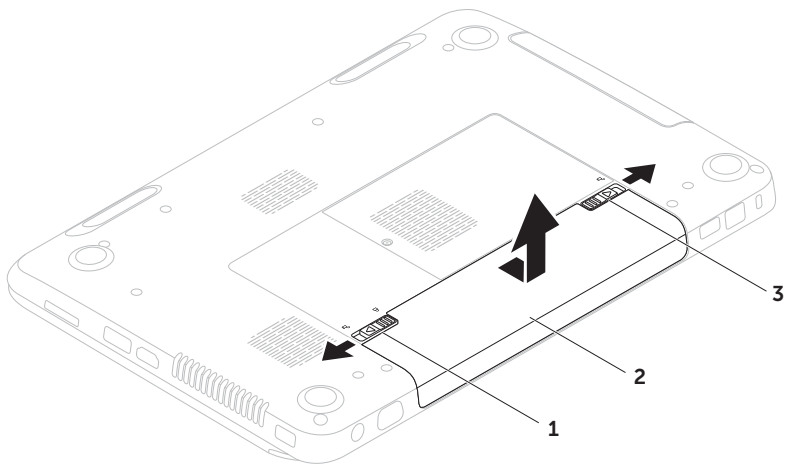

Software Features

FastAccess Facial Recognition

Your computer may have the FastAccess facial recognition feature. This feature helps keep your Dell computer secure by learning the unique appearance of your face and uses this to verify your identity to automatically supply login information when you would normally enter this information yourself (such as for logging on to a Windows account or secure websites). For more information, click

Start  → **All Programs** → **FastAccess**.

Productivity and Communication

You can use your computer to create presentations, brochures, greeting cards, fliers, and spreadsheets. You can also edit and view digital photographs and images. Check your purchase order for software installed on your computer.

After connecting to the Internet, you can access websites, setup an e-mail account, and upload or download files.

Entertainment and Multimedia

You can use your computer to watch videos, play games, create your own CDs/DVDs, listen to music and Internet radio stations.

You can download or copy pictures and video files from portable devices, such as digital cameras and cell phones. Optional software applications enable you to organize and create music and video files that can be recorded to disc, saved on portable products such as MP3 players and handheld entertainment devices, or played and viewed directly on connected TVs, projectors, and home theater equipment.

Dell DataSafe Online Backup

 **NOTE:** Dell DataSafe Online is supported only on Windows operating systems.

 **NOTE:** A broadband connection is recommended for fast upload/download speeds.

Dell DataSafe Online is an automated backup and recovery service that helps protect your data and other important files from catastrophic incidents like theft, fire, or natural disasters. You can access the service on your computer using a password-protected account.

For more information, go to **DellDataSafe.com**.

To schedule backups:

1. Double-click the Dell DataSafe Online icon  in the notification area of your desktop.
2. Follow the instructions on the screen.

Dell Stage

The Dell Stage software installed on your computer provides access to your favorite media applications.

To launch Dell Stage, click **Start**  →

All Programs → **Dell Stage** → **Dell Stage**.

 **NOTE:** Some of the applications on Dell Stage can also be launched from the **All Programs** menu.

You can customize Dell Stage as follows:

- Rearrange an application shortcut — Select and hold the application shortcut until it blinks and then drag the application shortcut to a desired location on Dell Stage.
- Minimize — Drag the Dell Stage window to the bottom of the screen.
- Personalize — Select the settings icon and then choose the desired option.

The following are the applications available on Dell Stage:

- **NOTE:** Some of the applications may not be available based on the selections you made while purchasing your computer.
- **MUSIC** — Play music or browse through your music files by album, artist, or song title. You can also listen to radio stations from across the globe. The optional Napster application allows you to download songs when connected to the Internet.
- **YOU PAINT** — Draw and edit pictures.
- **DOCUMENTS** — Provides quick access to the Documents folder on your computer.

- **PHOTO** — View, organize, or edit your pictures. You can create slideshows and collections of your pictures and upload them to **Facebook** or **Flickr** when connected to the Internet.
- **DELL WEB** — Provides a preview of up to four of your favorite web pages. Click the web page preview to open it in the web browser.
- **VIDEO** — View videos. The optional CinemaNow application allows you to purchase or rent movies and TV shows when connected to the Internet.
- **SHORTCUTS** — Provides quick access to your frequently-used programs.
- **STICKYNOTES** — Create notes or reminders. These notes will appear on the bulletin board the next time you access STICKYNOTES. You can also save notes on your desktop.
- **Web Tile** — Provides a preview of up to four of your favorite web pages. The tile allows you to add, edit, or delete a web page preview. Click the web page preview to open it in the web browser. You can also create multiple Web Tiles through the Apps Gallery.

Solving Problems

This section provides troubleshooting information for your computer. If you cannot solve your problem using the following guidelines, see “Using Support Tools” on page 62 or “Contacting Dell” on page 82.

 **WARNING:** Only trained service personnel should remove the computer cover. See the *Service Manual* at support.dell.com/manuals for advanced service instructions.

Beep Codes

Your computer might emit a series of beeps during start-up if there are errors or problems. This series of beeps, called a beep code, identifies a problem. If this occurs, write down the beep code and contact Dell (see “Contacting Dell” on page 82) for assistance.

 **NOTE:** To replace parts, see the *Service Manual* at support.dell.com.

Beep Code	Possible Problem
One	Possible system board failure – BIOS ROM checksum failure
Two	No RAM detected NOTE: If you installed or replaced the memory module, ensure that the memory module is seated properly.
Three	Possible system board failure – Chipset error
Four	RAM read/write failure
Five	Real Time Clock failure
Six	Video card or chip failure
Seven	Processor failure
Eight	Display failure

Network Problems

Wireless Connections

If the wireless network connection is lost —

The wireless router is offline or wireless has been disabled on the computer.

- Check your wireless router to ensure it is powered on and connected to your data source (cable modem or network hub).
- Check if wireless is enabled on the computer (see “Enable or Disable Wireless (Optional)” on page 14).
- Re-establish your connection to the wireless router (see “Setting Up a Wireless Connection” on page 18).
- Interference may be blocking or interrupting your wireless connection. Try moving the computer closer to your wireless router.

Wired Connections

If the wired network connection is lost —

The network cable is loose or damaged.

Check the network cable to ensure it is plugged in and not damaged.

Power Problems

If the power light is off — The computer is either turned off, in hibernate mode, or is not receiving power.

- Press the power button. The computer resumes normal operation if it is off or in hibernate mode.
- Reseat the AC adapter cable into the power connector on the computer, into the AC adapter, and to the electrical outlet.
- If the AC adapter cable is plugged into a power strip, ensure that the power strip is plugged into an electrical outlet and that the power strip is turned on. Also bypass power protection devices, power strips, and power extension cables to verify that the computer turns on properly.
- Ensure that the electrical outlet is working by testing it with another device, such as a lamp.

- Check the AC adapter cable connections. If the AC adapter has a light, ensure that the light on the AC adapter is on.
- If the problem persists, contact Dell (see “Contacting Dell” on page 82).

If the power light is solid white and the computer is not responding — The display may not be responding.

- Press the power button until the computer turns off and then turn it back on.
- If the problem persists, contact Dell (see “Contacting Dell” on page 82).

If the power light is breathing white — The computer is in standby mode or the display may not be responding.

- Press a key on the keyboard, move the connected mouse or a finger on the touch pad, or press the power button to resume normal operation.
- If the display is not responding, press the power button until the computer turns off and then turn it back on.
- If the problem persists, contact Dell (see “Contacting Dell” on page 82).

If you encounter interference that hinders reception on your computer — An unwanted signal is creating interference by interrupting or blocking other signals. Some possible causes of interference are:

- Power, keyboard, and mouse extension cables.
- Too many devices connected to a power strip.
- Multiple power strips connected to the same electrical outlet.

Memory Problems

If you receive an insufficient memory message —

- Save and close any open files and exit any open programs you are not using to see if that resolves the problem.
- See the software documentation for minimum memory requirements. If necessary, install additional memory (see the *Service Manual* at support.dell.com/manuals).
- Reseat the memory module(s) into the connector(s) (see the *Service Manual* at support.dell.com/manuals).
- If the problem persists, contact Dell (see “Contacting Dell” on page 82).

If you experience other memory problems —

- Run Dell Diagnostics (see “Dell Diagnostics” on page 64).
- If the problem persists, contact Dell (see “Contacting Dell” on page 82).

Lockups and Software Problems

If the computer does not start up — Ensure that the AC adapter cable is firmly connected to the computer and to the electrical outlet.

If a program stops responding —

End the program:

1. Press <Ctrl><Shift><Esc> simultaneously.
2. Click **Applications**.
3. Select the program that is no longer responding
4. Click **End Task**.

If a program crashes repeatedly — Check the software documentation. If necessary, uninstall and then reinstall the program.

 **NOTE:** Software usually includes installation instructions in its documentation or on the CD.

If the computer stops responding or a solid blue screen appears —

 **CAUTION: You might lose data if you are unable to perform an operating system shutdown.**

If you are unable to get a response by pressing a key on your keyboard, or by moving the connected mouse or a finger on the touch pad, press the power button for at least 8 to 10 seconds until the computer turns off and then restart your computer.

If a program is designed for an earlier Microsoft Windows operating system —

Run the Program Compatibility Wizard. The Program Compatibility Wizard configures a program so that it runs in an environment similar to an earlier version of Microsoft Windows operating system.

To run the Program Compatibility Wizard:

1. Click **Start**  → **Control Panel** → **Programs** → **Run programs made for previous versions of Windows**.
2. In the welcome screen, click **Next**.
3. Follow the instructions on the screen.

Solving Problems

If you have other software problems —



- Back up your files immediately.
- Use a virus-scanning program to check the hard drive or CDs.
- Save and close any open files or programs and shut down your computer through the **Start**  menu.
- Check the software documentation or contact the software manufacturer for troubleshooting information:
 - Ensure that the program is compatible with the operating system installed on your computer.
 - Ensure that your computer meets the minimum hardware requirements needed to run the software. See the software documentation for information.
- Ensure that the program is installed and configured properly.
- Verify that the device drivers do not conflict with the program.
- If necessary, uninstall and then reinstall the program.
- Write down any error message that is displayed to help in troubleshooting when contacting Dell.

Using Support Tools

Dell Support Center

All the support you need – one convenient location.

The **Dell Support Center** provides system alerts, performance improvement offers, system information, and links to other Dell tools and diagnostic services.

To launch the application, press the Dell Support Center button  on your keyboard or click **Start**  → **All Programs** → **Dell** → **Dell Support Center** → **Launch Dell Support Center**.

The **Dell Support Center** home page displays your computer's model number, service tag, express service code, warranty status, and alerts on improving the performance of your computer.

The home page also provides links to access:

PC Checkup — Run hardware diagnostics, see which program occupies the maximum memory on your hard drive, and track the changes made to your computer each day.

PC Checkup Utilities

- **Drive Space Manager** — Manage your hard drive using a visual representation of space consumed by each type of file.
- **Performance and Configuration History** — Monitor system events and changes over time. This utility displays all hardware scans, tests, system changes, critical events and restoration points on the day they occurred.

Detailed System Information — View detailed information about your hardware and operating system configurations; access copies of your service contracts, warranty information, and warranty renewal options.

Get Help — View Dell Technical Support options, Customer Support, Tours and Training, Online Tools, Owner's Manual, Warranty Information, FAQs, and so on.

Backup and Recovery — Create recovery media, launch recovery tool, and online file backup.

System Performance Improvement

Offers — Acquire software and hardware solutions that will help improve your system performance.

For more information about **Dell Support Center** and to download and install the available support tools, go to **DellSupportCenter.com**.

My Dell Downloads

 **NOTE:** My Dell Downloads may not be available in all regions.

Some of the software pre-installed on your new Dell computer do not include a backup CD or DVD. This software is available on the My Dell Downloads website. From this website you can download available software for reinstallation or create your own backup media.

To register and use My Dell Downloads:

1. Go to **DownloadStore.dell.com/media**.
2. Follow the instructions on the screen to register and download the software.
3. Reinstall the software or create a backup media for future use.

Hardware Troubleshooter

If a device is either not detected during the operating system setup or is detected but incorrectly configured, you can use the **Hardware Troubleshooter** to resolve the incompatibility.

To start the Hardware Troubleshooter:

1. Click **Start**  → **Help and Support**.
2. Type `hardware troubleshooter` in the search field and press <Enter> to start the search.
3. In the search results, select the option that best describes the problem and follow the remaining troubleshooting steps.

Dell Diagnostics

If you experience a problem with your computer, perform the checks in “Lockups and Software Problems” on page 58 and run Dell Diagnostics before you contact Dell for technical assistance.

Ensure that the device you want to test displays in the system setup utility and is active. To enter the system setup (BIOS) utility, turn on (or restart) your computer and press <F2> when the Dell logo appears.

Starting Dell Diagnostics

When you run Dell diagnostics, the computer invokes the Enhanced Pre-boot System Assessment (ePSA). The ePSA includes a series of diagnostic tests for devices such as the system board, keyboard, display, memory, hard drive, and so on.

1. Turn on (or restart) your computer.
2. When the DELL logo appears, press <F12> immediately.

 **NOTE:** If you wait too long and the operating system logo appears, continue to wait until you see the Microsoft Windows desktop; then, shut down your computer and try again.

3. Select **Diagnostics** from the boot menu and press <Enter>.

During the assessment, answer any questions that appear.

- If a failure is detected, the computer stops and beeps. To stop the assessment and restart the computer, press <n>; to continue to the next test, press <y>; to retest the component that failed, press <r>.
- If failures are detected during the Enhanced Pre-boot System Assessment, write down the error code(s) and contact Dell (for more information, see "Contacting Dell" on page 82).

If the Enhanced Pre-boot System Assessment completes successfully, the following message appears "Do you want to run the remaining memory tests? This will take about 30 minutes or more. Do you want to continue? (Recommended)."

If you are experiencing memory issues, press <y>, otherwise press <n>. The following message is displayed: "Enhanced Pre-boot System Assessment Complete".

Click <Exit> to reboot your computer.

Restoring Your Operating System

You can restore the operating system on your computer using any of the following options:

 **CAUTION:** Using Dell Factory Image Restore or the *Operating System* disc to restore your operating system permanently deletes all data files on your computer. If possible, backup your data files before using these options.

Option	Use
System Restore	as the first solution
Dell DataSafe Local Backup	when System Restore does not resolve your problem
System recovery media	when operating system failure prevents the use of System Restore and Dell DataSafe Local Backup when installing the Dell factory-installed software on a newly installed hard drive
Dell Factory Image Restore	to restore your computer to the operating state it was in when you received your computer
<i>Operating System</i> disc	to reinstall only the operating system on your computer

 **NOTE:** The *Operating System* disc may not ship with your computer.

System Restore

The Microsoft Windows operating systems provide a System Restore option which allow you to return your computer to an earlier operating state (without affecting data files) if changes to the hardware, software, or other system settings have left the computer in an undesirable operating state. Any changes that System Restore makes to your computer are completely reversible.

 **CAUTION: Make regular backups of your data files. System Restore does not monitor your data files or recover them.**

Starting System Restore

1. Click **Start** .
2. In the search box, type `System Restore` and press <Enter>.

 **NOTE:** The **User Account Control** window may appear. If you are an administrator on the computer, click **Continue**; otherwise, contact your administrator to continue the desired action.

3. Click **Next** and follow the instructions on the screen.

In the event that System Restore did not resolve the issue, you may undo the last system restore.

Undoing the Last System Restore

 **NOTE:** Before you undo the last system restore, save and close all open files and exit any open programs. Do not alter, open, or delete any files or programs until the system restoration is complete.

1. Click **Start** .
2. In the search box, type `System Restore` and press <Enter>.
3. Click **Undo my last restoration** and click **Next**.

Dell DataSafe Local Backup

 **CAUTION:** Using Dell DataSafe Local Backup to restore your operating system permanently removes any programs or drivers installed after you received your computer. Create backup media of applications you need to install on your computer before using Dell DataSafe Local Backup. Use Dell DataSafe Local Backup only if System Restore did not resolve your operating system problem.

 **CAUTION:** Although Dell DataSafe Local Backup is designed to preserve the data files on your computer, it is recommended that you backup your data files before using Dell DataSafe Local Backup.

 **NOTE:** Dell DataSafe Local Backup may not be available in all regions.

 **NOTE:** If Dell DataSafe Local Backup is not available on your computer, use Dell Factory Image Restore (see “Dell Factory Image Restore” on page 72) to restore your operating system.

You can use Dell DataSafe Local Backup to restore your hard drive to the operating state it was in when you purchased your computer, while preserving the data files.

Dell DataSafe Local Backup allows you to:

- Backup and restore your computer to an earlier operating state
- Create system recovery media

Dell DataSafe Local Backup Basic

To restore the Dell factory-installed software while preserving the data files:

1. Turn off your computer.
2. Disconnect all the devices (USB drive, printer, and so on) connected to the computer and remove any newly added internal hardware.

 **NOTE:** Do not disconnect the AC adapter.

3. Turn on your computer.
4. When the DELL logo appears, press <F8> several times to access the **Advanced Boot Options** window.

 **NOTE:** If you wait too long and the operating system logo appears, continue to wait until you see the Microsoft Windows desktop; then, shut down your computer and try again.

5. Select **Repair Your Computer**.

Restoring Your Operating System

6. Select **Dell DataSafe Restore and Emergency Backup** from the **System Recovery Options** menu and follow the instructions on the screen.

 **NOTE:** The restoration process may take an hour or more depending on the size of the data to be restored.

 **NOTE:** For more information, see knowledge base article 353560 at support.dell.com.

Upgrading to Dell DataSafe Local Backup Professional

 **NOTE:** Dell DataSafe Local Backup Professional may be installed on your computer, if you ordered it at the time of purchase.

Dell DataSafe Local Backup Professional provides additional features that allow you to:

- Backup and restore your computer based on file types
- Backup files to a local storage device
- Schedule automated backups

To upgrade to Dell DataSafe Local Backup Professional:

1. Double-click the Dell DataSafe Local Backup icon  in the notification area of your desktop.
2. Click **UPGRADE NOW!**
3. Follow the instructions on the screen.

System Recovery Media

 **CAUTION:** Although the system recovery media is designed to preserve the data files on your computer, it is recommended that you backup your data files before using the system recovery media.

You can use the system recovery media, created using Dell DataSafe Local Backup, to return your hard drive to the operating state it was in when you purchased the computer while preserving the data files on your computer.

Use the system recovery media in case of:

- Operating system failure that prevents the use of the recovery options installed on your computer.
- Hard drive failure that prevents data from being recovered.

To restore the Dell factory-installed software of your computer using the system recovery media:

1. Insert the system recovery disc or USB key and restart the computer.
2. When the DELL logo appears, press <F12> immediately.

 **NOTE:** If you wait too long and the operating system logo appears, continue to wait until you see the Microsoft Windows desktop; then, shut down your computer and try again.

3. Select the appropriate boot device from the list and press <Enter>.
4. Follow the instructions on the screen.

Dell Factory Image Restore

 **CAUTION:** Using Dell Factory Image Restore to restore your operating system permanently deletes all data on the hard drive and removes any programs or drivers installed after you received your computer. If possible, back up the data before using this option. Use Dell Factory Image Restore only if System Restore did not resolve your operating system problem.

 **NOTE:** Dell Factory Image Restore may not be available in certain countries or on certain computers.

 **NOTE:** If Dell Factory Image Restore is not available on your computer, use Dell DataSafe Local Backup (see “Dell DataSafe Local Backup” on page 68) to restore your operating system.

Use Dell Factory Image Restore only as the last method to restore your operating system. This option restores your hard drive to the operating state it was in when you purchased the computer. Any programs or files added since you received your computer—including data files—are permanently deleted from the hard drive. Data files include documents, spreadsheets, e-mail messages, digital photos, music files, and so on. If possible, back up all data before using Dell Factory Image Restore.

Starting Dell Factory Image Restore

1. Turn on the computer.
2. When the DELL logo appears, press <F8> several times to access the **Advanced Boot Options** window.

 **NOTE:** If you wait too long and the operating system logo appears, continue to wait until you see the Microsoft Windows desktop; then, shut down your computer and try again.

3. Select **Repair Your Computer**.

The **System Recovery Options** window appears.

4. Select a keyboard layout and click **Next**.

5. To access the recovery options, log on as a local user. To access the command prompt, type `administrator` in the **User name** field, then click **OK**.

6. Click **Dell Factory Image Restore**.

The **Dell Factory Image Restore** welcome screen appears.

 **NOTE:** Depending upon your configuration, you may need to select **Dell Factory Tools**, then **Dell Factory Image Restore**.

7. Click **Next**.

The **Confirm Data Deletion** screen appears.

 **NOTE:** If you do not want to proceed with the Factory Image Restore, click **Cancel**.



8. Select the check box to confirm that you want to continue to reformat the hard drive and restore the system software to the factory condition, then click **Next**.

The restore process begins and may take five or more minutes to complete. A message appears when the operating system and factory-installed applications have been restored to factory condition.

9. Click **Finish** to restart the computer.

Getting Help

If you experience a problem with your computer, you can complete the following steps to diagnose and troubleshoot the problem:

1. See “Solving Problems” on page 54 for information and procedures that pertain to the problem your computer is experiencing.
2. See “Dell Diagnostics” on page 64 for procedures on how to run diagnostic tests.
3. Fill out the “Diagnostic Checklist” on page 81.
4. Use Dell’s extensive suite of online services available at Dell Support (support.dell.com) for help with installation and troubleshooting procedures. See “Online Services” on page 76 for a more extensive list of Dell Support online.
5. If the preceding steps have not resolved the problem, see “Before You Call” on page 80.
 -  **NOTE:** Call Dell Support from a telephone near or at the computer so that the support staff can assist you with any necessary procedures.
 -  **NOTE:** Dell’s Express Service Code system may not be available in all countries.

When prompted by Dell’s automated telephone system, enter your Express Service Code to route the call directly to the proper support personnel. If you do not have an Express Service Code, open the **Dell Accessories** folder, double-click the **Express Service Code** icon, and follow the directions.

 **NOTE:** Some of the services are not always available in all locations outside the continental U.S. Call your local Dell representative for information on availability.

Technical Support and Customer Service

Dell's support service is available to answer your questions about Dell hardware. Our support staff use computer-based diagnostics to provide fast, accurate answers.

To contact Dell's support service, see "Before You Call" on page 80 and then see the contact information for your region or go to **support.dell.com**.

DellConnect

DellConnect is a simple online access tool that allows a Dell service and support associate to access your computer through a broadband connection, diagnose your problem and repair it all under your supervision. For more information, go to **dell.com/DellConnect**.

Online Services

You can learn about Dell products and services on the following websites:

- **dell.com**
- **dell.com/ap** (Asian/Pacific countries only)
- **dell.com/jp** (Japan only)
- **euro.dell.com** (Europe only)
- **dell.com/la** (Latin American and Caribbean countries)
- **dell.ca** (Canada only)

You can access Dell Support through the following websites and e-mail addresses:

Dell Support Websites

- **support.dell.com**
- **support.jp.dell.com** (Japan only)
- **support.euro.dell.com** (Europe only)
- **supportapj.dell.com** (Asia Pacific only)

Dell Support E-mail Addresses

- **mobile_support@us.dell.com**
- **support@us.dell.com**
- **la-techsupport@dell.com** (Latin America and Caribbean countries only)
- **apsupport@dell.com** (Asian/Pacific countries only)

Dell Marketing and Sales E-mail Addresses

- **apmarketing@dell.com** (Asian/Pacific countries only)
- **sales_canada@dell.com** (Canada only)

Anonymous File Transfer Protocol (FTP)

- **ftp.dell.com**

Log in as user: `anonymous`, and use your e-mail address as your password.

Automated Order-Status Service

To check on the status of any Dell products that you have ordered, you can go to **support.dell.com**, or you can call the automated order-status service. A recording prompts you for the information needed to locate and report on your order.

If you have a problem with your order, such as missing parts, wrong parts, or incorrect billing, contact Dell for customer assistance. Have your invoice or packing slip handy when you call.

For the telephone number to call for your region, see “Contacting Dell” on page 82.

Product Information

If you need information about additional products available from Dell, or if you would like to place an order, go to the Dell website at **dell.com**. For the telephone number to call for your region or to speak to a sales specialist, see “Contacting Dell” on page 82.

Returning Items for Repair Under Warranty or for Credit

Prepare all items being returned, whether for repair or credit, as follows:

 **NOTE:** Before you return the product to Dell, ensure that you back up any data on the hard drive(s) and on any other storage device in the product. Remove any and all confidential, proprietary and personal information, as well as removable media, such as CDs and media cards. Dell is not responsible for any of your confidential, proprietary or personal information; lost or corrupted data; or damaged or lost removable media that may be included with your return.

1. Call Dell to obtain a Return Material Authorization Number, and write it clearly and prominently on the outside of the box. For the telephone number to call for your region, see “Contacting Dell” on page 82.
2. Include a copy of the invoice and a letter describing the reason for the return.
3. Include a copy of the Diagnostics Checklist (see “Diagnostic Checklist” on page 81), indicating the tests that you have run and any error messages reported by Dell Diagnostics (see “Dell Diagnostics” on page 64).
4. Include any accessories that belong with the item(s) being returned (AC adapter cable, software, guides, and so on) if the return is for credit.

5. Pack the equipment to be returned in the original (or equivalent) packing materials.

 **NOTE:** You are responsible for paying shipping expenses. You are also responsible for insuring any product returned, and you assume the risk of loss during shipment to Dell. Collect On Delivery (C.O.D.) packages are not accepted.

 **NOTE:** Returns that are missing any of the preceding requirements will be refused at Dell's receiving dock and returned to you.

Before You Call

- NOTE:** Have your Express Service Code ready when you call. The code helps Dell's automated-support telephone system direct your call more efficiently. You may also be asked for your Service Tag.

Locating Your Service Tag and Express Service Code

The Service Tag and Express Service Code for your computer can be found on a label at the bottom of your computer.

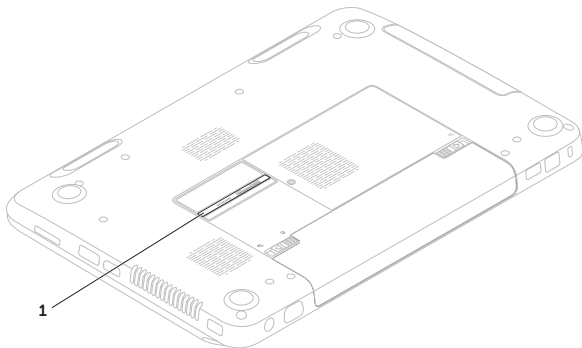

1 Service Tag and Express Service Code

Remember to fill out the following Diagnostic Checklist. If possible, turn on your computer before you call Dell for assistance and call from a telephone at or near the computer. You may be asked to type some commands at the keyboard, relay detailed information during operations, or try other troubleshooting steps possible only at the computer itself. Ensure that the computer documentation is available.

Diagnostic Checklist

- Name:
- Date:
- Address:
- Phone number:
- Service Tag (bar code on the bottom of the computer):
- Express Service Code:
- Return Material Authorization Number (if provided by Dell support technician):
- Operating system and version:
- Devices:
- Expansion cards:
- Are you connected to a network? Yes/No
- Network, version, and network adapter:
- Programs and versions:

Getting Help

See your operating system documentation to determine the contents of the computer's start-up files. If the computer is connected to a printer, print each file. Otherwise, record the contents of each file before calling Dell.

- Error message, beep code, or diagnostic code:
- Description of problem and troubleshooting procedures you performed:

Contacting Dell

For customers in the United States, call 800-WWW-DELL (800-999-3355).

 **NOTE:** If you do not have an active Internet connection, you can find contact information on your purchase invoice, packing slip, bill, or Dell product catalog.

Dell provides several online and telephone-based support and service options. Availability varies by country and product, and some services may not be available in your area.

To contact Dell for sales, technical support, or customer service issues:

1. Go to **dell.com/ContactDell**.
2. Select your country or region.
3. Select the appropriate service or support link based on your requirement.
4. Choose the method of contacting Dell that is convenient for you.

Finding More Information and Resources

If you need to:

See:

reinstall your operating system

"System Recovery Media" on page 71

run a diagnostic program for your computer

"Dell Diagnostics" on page 64

reinstall system software

"My Dell Downloads" on page 63

for more information about the Microsoft Windows operating system and features

support.dell.com

find your Service Tag/Express Service Code — You must use the service tag to identify your computer on **support.dell.com** or to contact technical support

the bottom of your computer
"Dell Support Center" on page 62

upgrade your computer with new or additional components like a new hard drive
reinstall or replace a worn or defective part

the *Service Manual* at
support.dell.com/manuals



NOTE: In some countries, opening and replacing parts of your computer may void your warranty. Check your warranty and return policies before working inside your computer.

If you need to:

find safety best practices information for your computer

review Warranty information, Terms and Conditions (U.S. only), Safety instructions, Regulatory information, Ergonomics information, and End User License Agreement

find drivers and downloads; readme files

access technical support and product help

check on your order status for new purchases

find solutions and answers to common questions

locate information for last-minute updates about technical changes to your computer or advanced technical-reference material for technicians or experienced users



See:

the safety and regulatory documents that shipped with your computer and also see the Regulatory Compliance Homepage at **dell.com/regulatory_compliance**

support.dell.com

Specifications

This section provides information that you may need when setting up, updating drivers for, and upgrading your computer.

-  **NOTE:** Offerings may vary by region. For more information regarding the configuration of your computer, see the **Detailed System Information** section in the Dell Support Center. To launch the Dell Support Center, click **Start**  → **All Programs** → **Dell** → **Dell Support Center** → **Launch Dell Support Center**.

Computer Model

Dell Inspiron N5110

Computer Information

System chipset	Mobile Intel 6 Series
Processor types	Intel Core i3 Intel Core i5 Intel Core i7 Intel Pentium Dual Core

Memory

Memory module connector	two user-accessible SODIMM connectors
Memory module capacities	1 GB, 2 GB, and 4 GB
Minimum memory	2 GB
Maximum memory	8 GB

Memory

Possible memory configurations 2 GB, 3 GB, 4 GB, 6 GB, and 8 GB

Memory type 1333 MHz SODIMM DDR3

 **NOTE:** For instructions on upgrading the memory, see the *Service Manual* at support.dell.com/manuals.

Connectors

Audio one microphone-in connector and one stereo headphones/speakers connector

Mini-Card one full Mini-Card slot (optional)
one half Mini-Card slot

HDMI connector one 19-pin connector

Network adapter one RJ45 connector

Connectors

USB one 4-pin USB 2.0-compliant connector

two 4-pin USB 3.0-compliant connectors

Video one 15-hole connector

eSATA one 7-pin/4-pin eSATA/USB combo connector with PowerShare

Media Card Reader one 8-in-1 slot

Specifications

Media Card Reader

Cards supported	Secure Digital (SD) memory card
	Secure Digital Extended Capacity (SDXC)
	Secure Digital High Capacity (SDHC)
	Memory Stick (MS)
	Memory Stick PRO (MS-PRO)
	MultiMedia Card (MMC)
	MultiMedia Card plus (MMC+)
	xD-Picture Card

Keyboard

Number of keys	86 (U.S. and Canada); 87 (Europe); 90 (Japan); 87 (Brazil)
----------------	--

Communications

Modem (optional)	external V.92 56 K USB modem
Network adapter	10/100 Ethernet LAN on system board
Wireless	WLAN, WWAN (optional), WiMax/Wi-Fi abgn/agn, and Bluetooth wireless technology (optional)/ WiDi (optional)

Audio

Audio controller	IDT 92HD87
Speakers	2 x 2 Watt
Volume controls	software program menus and media controls

Video

Discrete:

Video controller	AMD Radeon HD 6470M /7450M
------------------	----------------------------

	NVIDIA GeForce GT 525M
--	------------------------

Video memory	512 MB/1 GB DDR3
--------------	------------------

UMA:

Video controller	Intel HD Graphics 3000
------------------	------------------------

Video memory	up to 1.6 GB of shared memory
--------------	-------------------------------

Camera

Camera resolution	1.0 megapixel
-------------------	---------------

Camera type	widescreen HD
-------------	---------------

Video resolution	1280 x 720
------------------	------------

Display

Type	15.6-inch HD WLED with TrueLife
------	---------------------------------

Dimensions:

Height	193.54 mm (7.62 inches)
--------	-------------------------

Width	344.23 mm (13.55 inches)
-------	--------------------------

Diagonal	396.42 mm (15.60 inches)
----------	--------------------------

Maximum resolution	1366 x 768
--------------------	------------

Refresh rate	60 Hz
--------------	-------

Operating angle	0° (closed) to 135°
-----------------	---------------------

Horizontal viewing angle	40/40
--------------------------	-------

Vertical viewing angle	15/30 (H/L)
------------------------	-------------

Pixel pitch	0.252 mm x 0.252 mm
-------------	---------------------

Specifications

Touch Pad

X/Y position resolution (graphics table mode) 240 cpi

Size:

Height 56 mm (2.20 inches)

Width 100 mm (3.94 inches)

Battery

6-cell "smart" lithium ion:

Height 22.80 mm (0.90 inches)

Width 214 mm (8.43 inches)

Depth 57.64 mm (2.27 inches)

Weight 0.34 kg (0.75 lb)

Battery

9-cell "smart" lithium ion:

Height 22.80 mm (0.90 inches)

Width 214 mm (8.43 inches)

Depth 78.76 mm (3.10 inches)

Weight 0.52 kg (1.15 lb)

Voltage 11.1 VDC

Charge time (approximate) 4 hours (when the computer is turned off)

Operating time battery operating time varies depending on operating conditions

Coin-cell battery CR-2032

Physical

Height	30.70 mm to 35.28 mm (1.21 inches to 1.39 inches)
Width	376 mm (14.8 inches)
Depth	260.20 mm (10.24 inches)
Weight (with 6-cell battery and optical drive)	configurable to less than 2.54 kg (5.40 lb)

AC Adapter

 **NOTE:** Use only AC adapters specified for use with your computer. See the safety information that shipped with your computer.

Input voltage	100-240 VAC
Input current (maximum)	1.5 A/1.6 A/1.7 A/ 2.3 A/2.5 A

AC Adapter

Input frequency	50-60 Hz
Output power	65 W/90 W/130 W
Output current:	
65 W	3.34 A
90 W	4.62 A
130 W	6.7 A
Rated output voltage	19.5 VDC
Temperature range:	
Operating	0° to 40°C (32° to 104°F)
Storage	-40° to 70°C (-40° to 158°F)

Specifications

Computer Environment

Temperature range:

Operating 0° to 35°C
 (32° to 95°F)

Storage -40° to 65°C
 (-40° to 149°F)

Relative humidity (maximum):

Operating 10% to 90%
 (noncondensing)

Storage 5% to 95%
 (noncondensing)

Maximum vibration (using a random vibration spectrum that simulates user environment):

Operating 0.66 GRMS

Non-
Operating 1.30 GRMS

Computer Environment

Maximum shock (for operating — measured with Dell Diagnostics running on the hard drive and a 2-ms half-sine pulse; for non-operating — measured with the hard drive in head-parked position and a 2-ms half-sine pulse):

Operating 110 G

Non-
Operating 160 G

Altitude (maximum):

Operating -15.2 to 3048 m
 (-50 to 10,000 ft)

Storage -15.2 to 10,668 m
 (-50 to 35,000 ft)

Airborne
contaminant level G2 or lower as defined
 by ISA-S71.04-1985

Appendix

Information for NOM, or Official Mexican Standard (Only for Mexico)

The following information is provided in the device(s) described in this document in accordance with the requirements of the Official Mexican Standard (NOM):

Importer:

Dell México S.A. de C.V.

Paseo de la Reforma 2620 – Flat 11°

Col. Lomas Altas

11950 México, D.F.

Regulatory model number	Voltage	Frequency	Electricity consumption	Output voltage	Output intensity
P17F	100-240 VAC	50-60 Hz	1.5 A/1.6 A/ 1.7 A/2.3 A/2.5 A	19.5 VDC	3.34 A/4.62 A/ 6.7 A

For details, read the safety information that shipped with your computer.

For additional safety best practices information, see dell.com/regulatory_compliance.

Index

A

airflow, allowing **5**

B

backup and recovery **51**

battery status light **29**

C

calling Dell **80**

CDs, playing and creating **50**

computer capabilities **50**

computer, setting up **5**

connect(ing)

to the Internet **17**

Contacting Dell online **82**

customer service **75**

D

DataSafe Local Backup

Basic **69**

Professional **70**

DellConnect **75**

Dell Factory Image Restore **72**

Dell Stage **52**

Dell Support Center **62**

Diagnostic Checklist **81**

drivers and downloads **85**

DVDs, playing and creating **50**

E

E-mail addresses

for technical support **76**

eSATA connector **23**

F

finding more information **84**

FTP login, anonymous **76**

G

gestures

 Touch Pad **36**

H

hard drive activity light **29**

hardware problems

 diagnosing **64**

Hardware Troubleshooter **64**

HDMI connector **23**

help

 getting assistance and support **74**

I

Internet connection **17**

ISP

 Internet Service Provider **17**

M

memory problems

 solving **58**

N

network connection

 fixing **55**

O

Optical Drive

 emergency eject hole **40**

 Using **40**

P

power indicator light **29**

power problems, solving **56**

power strips, using **6**

Index

problems, solving **54**

products

information and purchasing **77**

R

resources, finding more **84**

restoring factory image **72**

S

Service Tag

locating **80**

setup, before you begin **5**

shipping products

for return or repair **78**

SIM card **12**

software features **50**

software problems **58**

solving problems **54**

specifications **86**

support e-mail addresses **76**

support sites

worldwide **75**

System Recovery Media **71**

system reinstall options **66**

System Restore **67**

T

Touch Pad

Gestures **36**

U

Using the Emergency Eject Hole **40**

V

ventilation, ensuring **5**

W

warranty returns **78**

Windows

- Program Compatibility Wizard **59**
- Windows Mobility Center **38**
- wired network
 - network cable, connecting **7**
- wireless network
 - connecting **14**
 - problems **55**



Printed in the U.S.A.

www.dell.com | support.dell.com



0HXN3VA03